

Thank you for purchasing this Crest TV Wall Mount.

Crest prides itself on supplying quality audio visual accessories to consumers and businesses throughout Australia. If you follow this guide carefully, we are confident this product will help maximise the enjoyment you obtain from your audio visual equipment for many years.

Please keep this guide for future reference.

TECHNICAL SUPPORT

If you have any questions regarding the warranty, installation or use of this product, please contact our Technical Support Centre on 1800 812 261.

INSTALLATION INSTRUCTIONS

IMPORTANT

1. Installation of this TV mount will be easier if two people are involved.
2. Some images in this guide may vary slightly from the actual components supplied.
3. Ensure this Installation Guide is completely read and understood before attempting installation.
4. Mount **MUST NOT** be installed solely in plasterboard, fibre cement and similar surfaces.
5. Mount **MUST** be installed in sound supporting structures such as those made of timber, steel or masonry using appropriate fasteners.
6. The supporting structure must be capable of sustaining the combined weight of the TV mount and the display otherwise the structure must be reinforced.
7. The fasteners supplied in this hardware pack allow for fixing into timber and masonry only. If installing into a supporting structure made of steel, appropriate fasteners must be used and sourced from an appropriate supplier.
8. Use appropriate tools and safety equipment and ensure adequate ventilation during installation.
9. If uncertain about any aspect of installation, contact Crest or an installation professional.

5 YEAR WARRANTY

Olbertz Holdings Pty Ltd ACN 010 003 933 trading as Crest Electronics (Crest Electronics) of 165 South Pine Road, Brendale, Queensland, 4500, Ph: 1800 812261, support@crest.com.au, warrants that if this Crest product purchased by you from Crest or a retail outlet is found by Crest to be defective in workmanship or materials within 5 years of the date of purchase, Crest Electronics will (at its election) either repair that product, replace the product, supply an equivalent product or pay the costs of repairing or replacing the product or acquiring an equivalent product.

This limited warranty will not extend to or cover any expenses associated with removing, demounting the original product or installing the repaired, replaced or equivalent product or all or any of its components, you must bear these expenses. It also does not cover damage or loss resulting from intentional or unintentional misuse of, tampering with, alterations to or incorrect installation of this product or use of this product for purposes other than that for which it is designed or in a manner inconsistent with the product's instructions. This limited warranty also does not apply to damage or loss resulting from fair wear and tear or events beyond Crest Electronics' control including but not limited to natural disasters.

In order to claim under this warranty, you must contact Crest Electronics and return to Crest Electronics (via our nominated reply paid address) the product and its components and proof of purchase (including the date and location of purchase) so that Crest can verify the defect and your purchase.

Our goods come with guarantees that cannot be excluded under the Australian Consumer Law. You are entitled to a replacement or refund for a major failure and compensation for any other reasonably foreseeable loss or damage. You are also entitled to have the goods repaired or replaced if the goods fail to be of acceptable quality and the failure does not amount to a major failure. The benefits given by this warranty are in addition to other rights and remedies which you may have under a law in relation to the goods or services to which the warranty relates.

TV COMPATIBILITY SPECIFICATIONS

Note the TV Compatibility Specification of this mount.

CBFP3F This model will suit most flat panel TV sizes from **32 to 60 inches (81 to 152cm)** as long as they weigh **50kg maximum** and possess a maximum mounting hole pattern of **600 x 600mm** (h x w)

TOOLS REQUIRED

Drywall (Timber Frame) Installation

- Stud finder
- Spirit level
- Pencil
- Drill
- Phillips head screwdriver
- 5 to 6mm diameter high speed drill bit
- Adjustable spanner













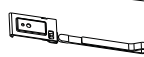





In addition, for Masonry Installation

- Drill with hammer function
- 10mm masonry drill bit
- Hammer



165 South Pine Rd
PO Box 5658
Brendale
Qld 4500

WALL MOUNT FASTENERS DIAGRAM

Item	Image	Description	Size	Qty	Item	Image	Description	Size	Qty
A		Wall Plate	Custom	1	M-G		Mounting Bolt	M8x15mm	4
B		Adapter Bracket	Custom	2	M-H		Mounting Bolt	M8x30mm	4
C		Supporting Spacer	Custom	1	M-I		Round Washer	5.5mmø	2
D		Supporting Spacer	Custom	1	M-J		Round Washer	9mmø	2
M-A		Mounting Bolt	M4x10mm	4	M-K		Plastic Spacer	6mmø	4
M-B		Mounting Bolt	M4x20mm	4	M-L		Plastic Spacer	8mmø	4
M-C		Mounting Bolt	M5x10mm	4	W-A		Lag Bolt	6.3x55mm	6
M-D		Mounting Bolt	M5x20mm	4	W-B		Masonry Anchor	Custom	6
M-E		Mounting Bolt	M6x10mm	4	W-C		Washer	6.5mmø	6
M-F		Mounting Bolt	M6x20mm	4					

Warranty and Installation Guide Slimline Flat Panel Wall Mount

STEP 1 – ATTACH WALL PLATE TO WALL

A. Installing in Drywall (Timber frame). See Figure 1.

1. Wall plate can be mounted to two studs. Use a stud finder to locate the centre of the studs.
2. Place wall plate on wall as a template. Mark the center of the four mounting holes. Make sure the mounting holes are on the stud centerline.
3. Drill four 3mm dia. holes 30mm deep, secure wall plate using four lag bolts (W-A) and four M6 washers (W-C) as shown in diagram.

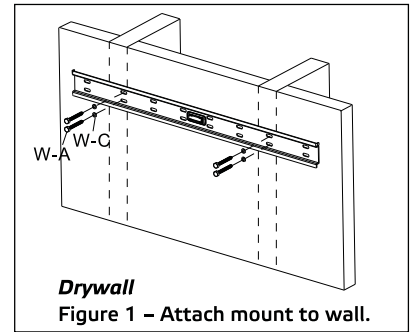

B. Installing in Masonry. See Figures 2 and 3.

1. Use the wall plate as a template to mark 6 hole areas on the wall- four in the top row slots and two more in the bottom row as shown in the diagram.
2. Pre-drill these holes with a 10mm masonry bit to at least 60mm in depth. Insert a concrete anchor (W-B) into each of these holes. Attach the wall plate to the wall using six lag bolts (W-A) and six M6 washers (W-C) as shown in the diagram.

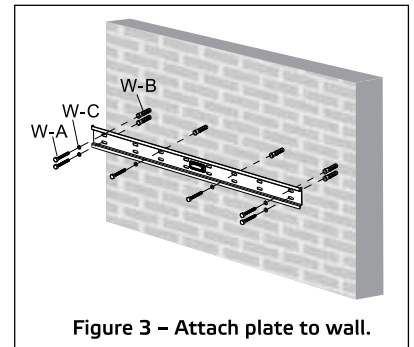
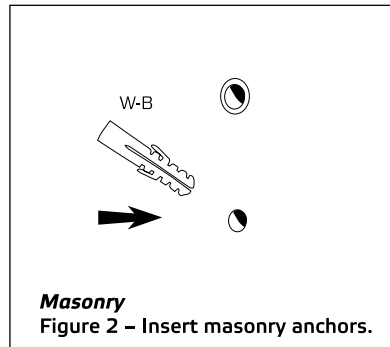

C. Installing Adapter Brackets. See Figure 4.

1. To prevent scratching the screen, set a cloth on a flat, level surface that will support the weight on the screen. Place screen face side down. Place adapter bracket and supporting spacer in the back of the screen, align to holes as shown in diagram.
2. Attach the adapter bracket and supporting spacer to the back of the screen using the appropriate combination of screws, washers and spacers as shown in the diagram.

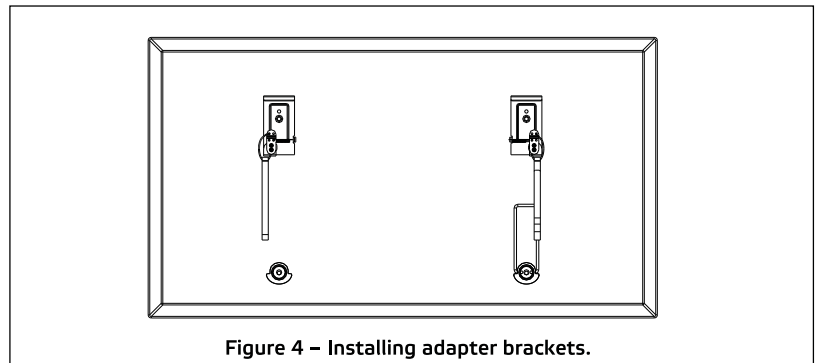

STEP 2 – ATTACH ARMS TO TV. See Figure 5.

For flat backed screen

1. Begin with the shortest length screw for flat backed screens or the longest screw for curved back screens, hand thread through washer and adapter bracket into screen as shown in the diagram.

For curved backed screen

2. Begin with the longest screw for curved back screens, hand thread through washer, the supporting spacers and adapter bracket into screen as shown in the diagram.
3. Screw must make at least three full turns into mounting hole to fit snug into place. Do not over tighten. If screw cannot make three full turns into place, select a longer screw. Repeat for remaining holes, level brackets and tighten screws. Spacers may not be used, depending on the type of screen.

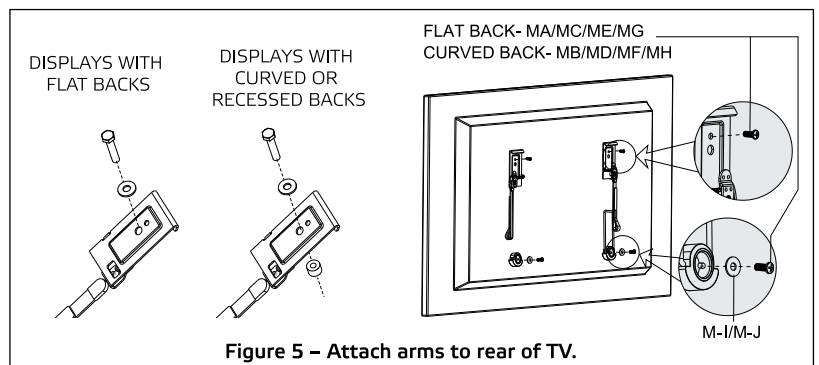

STEP 3 – MOUNT TV. See Figure 6.

1. With help of another person, carefully lift TV and securely hook arms over mount rods.
2. Slowly pull bottom of display away from the wall until kick stand of the supporting spacer (D) fully reaches its down position.
3. Attach or adjust cables as necessary on back of display.
4. To disengage kick stand, slightly pull display away from wall. Slowly allow display to return to wall.

